

[SPECIFICATIONS]

Image Size: $\frac{2}{3}$ $\frac{1}{2}$ $\frac{1}{3}$ $\frac{1}{4}$

Focal Length :	8mm	Flange Back :	17.526mm
Maximum Relative Aperture :	1:1.4	Operation :	Focus : Manual Iris : Manual
Iris :	F1.4 - Close	Operation Temperature :	-10 to +50
Angular Field of View :	56.5X43.9deg.	Mount :	C-Mount
Image Format :	8.8X6.6mm(D11mm)	Front Thread :	27mm P0.5
Minimum Object Distance :	0.1m(From Front Vertex)	Size, Weight :	D34.0X41.0mm, Approx. 83g
Optical Back Focal Distance :	9.5mm(In Air)		

[COMPOSITION]

- Lens1
- Lens Cap1
- Dust Cap1

[DIMENSIONS]

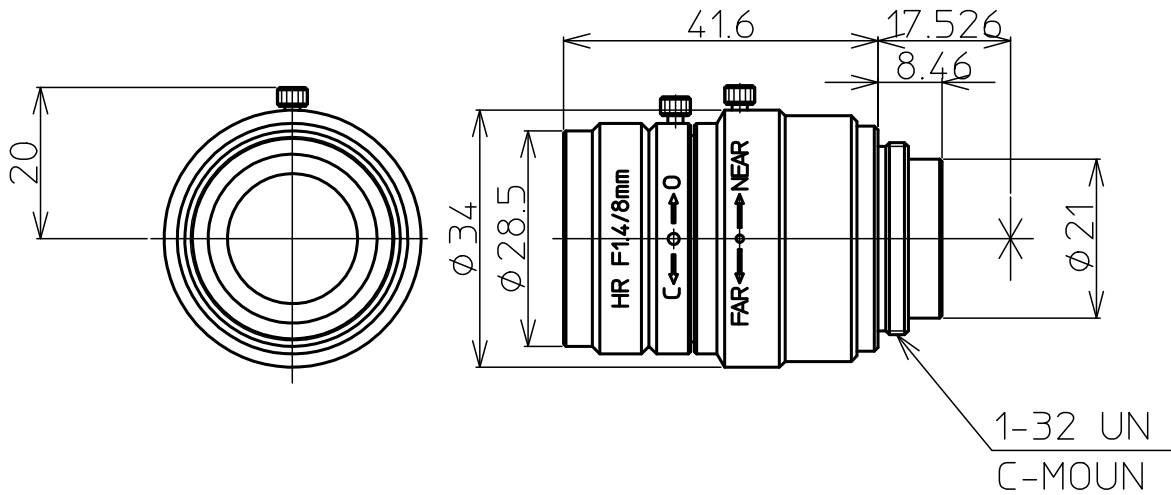

Unit:mm